



*Education
2020 Product Catalogue*

EDUCATION















FURNITURE SPECIALISTS

CONTENTS

TITLE

03 DESIGN YOUR TABLE!

TABLES

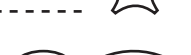
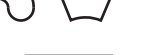
05	QUADRANT	
09	PENTAGON	
11	MODULAR	
13	FLAG	
15	TRIPOD	
16	ZAMPA	
17	ROUND	
18	SPADE	
19	STINGRAY	
20	TRUSS	
21	APPLE	
22	ECLIPSE	
23	AXE/BONE	
24	STAR	
25	CRESCENT/SEGMENT	
26	TEKNIK	
27	STUDENT	
28	TRANSIT	
29	EXTRA	



SEATING

- 31 OTTOMAN
 - 32 SWIFT
 - 33 SHELL/ANNE
 - 34 EDUTECH
 - 35 MULTI-PURPOSE
 - 36 LECTURE
 - 37 LAB
 - 38 EXECUTIVE
-

DESIGN Your Table!

Creating your very own Education Table could not be easier! Our Australian made range is versatile and fully customisable. Our strong and durable table frames are made from fully welded steel tubing and our table tops are constructed from commercial quality melamine board. Not only are our tables built to last and able to withstand the demands of today's collaborative learning environment, they are coupled with a three year warranty for peace of mind.

Choose your **SHAPE**

All of our ranges are designed to be used seamlessly both individually and alongside other Educational Tables. Pick from over a dozen unique designs that are sure to bring the classroom together!

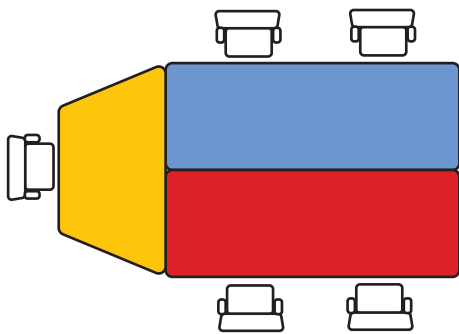

Page 11 - Modular Table Range

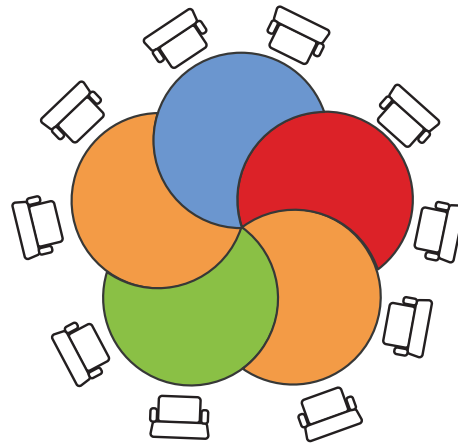

Page 22 - Eclipse Table Range

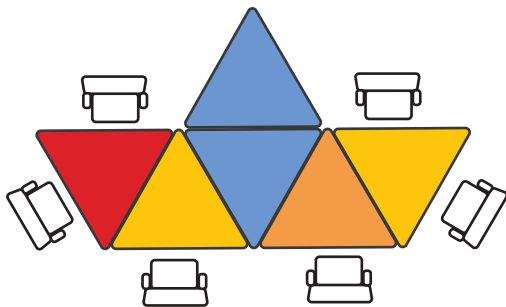

Page 20 - Truss Table Range

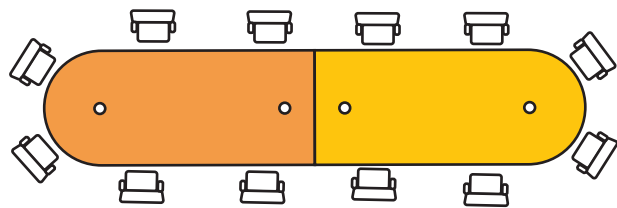

Page 26 - Teknik Table Range

Choose your COLOUR

Choose from a wide variety of tabletop colours from both our Core Colours as well as our Extended Laminex Range! Mix and match your choice with the Frame Colour to create a table that is right for you!

FRAME Colours

Core Colour Range

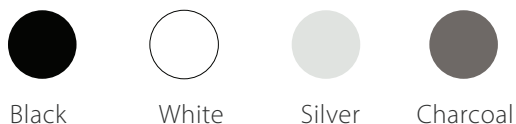

For Other Colours. Surcharges Apply, POA.

TOP Colours

Core Colour Range



Extended Laminex Colour Range



Price on application

Choose your LEG

Choose fixed or adjustable legs. Add lockable or non-lockable wheels for extra versatility to some or all legs.



Code 50
50mm Dia x 1.6mm RHS



Code 32
31.8mm x 1.6mm RHS



Code 38
38mm Dia x 1.6mm RHS

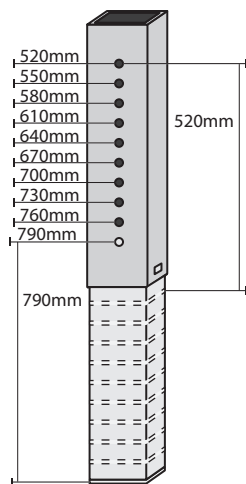

Code 40
Outer: 40mm x 1.6mm SHS
Inner: 36mm x 1.6mm SHS
520 to 790Hmm

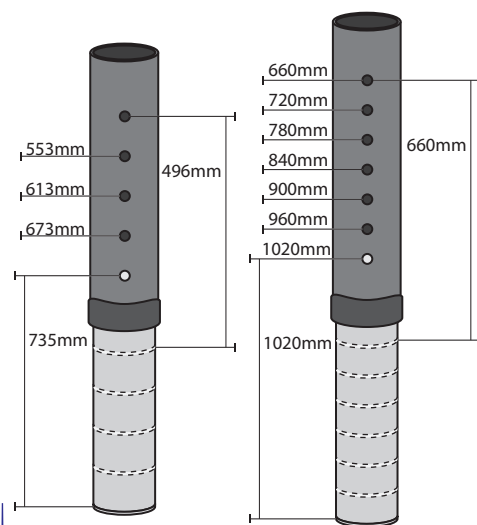

Code 42
Outer: 42mm Dia x 1.6mm RHS
Inner: 38mm Dia x 1.6mm RHS
Table Height 496 to 735Hmm
Counter Height 660mm to 1020mm



Adjustable Feet To Suit Square & Round Legs



Lockable & Non-Lockable Wheels

Available Legs	Leg Code
Round 50mm Non-Adjustable Leg	50
Square 32mm Non-Adjustable Leg	32
Round 38mm Non-Adjustable Leg	38
Square 40mm Pin-Adjustable Leg	40
Round 52mm Pin-Adjustable Leg	42

QUADRANT Table

Quadrant Tables offer a versatile shape, allowing for easy transformation of your space in minutes. The Quadrant range has been designed for durability and flexibility in today's learning environment. The Single Quadrant is designed for classrooms to support a variety of learning and teaching styles on demand. This table shape is dynamic, lending to collaborative learning spaces.



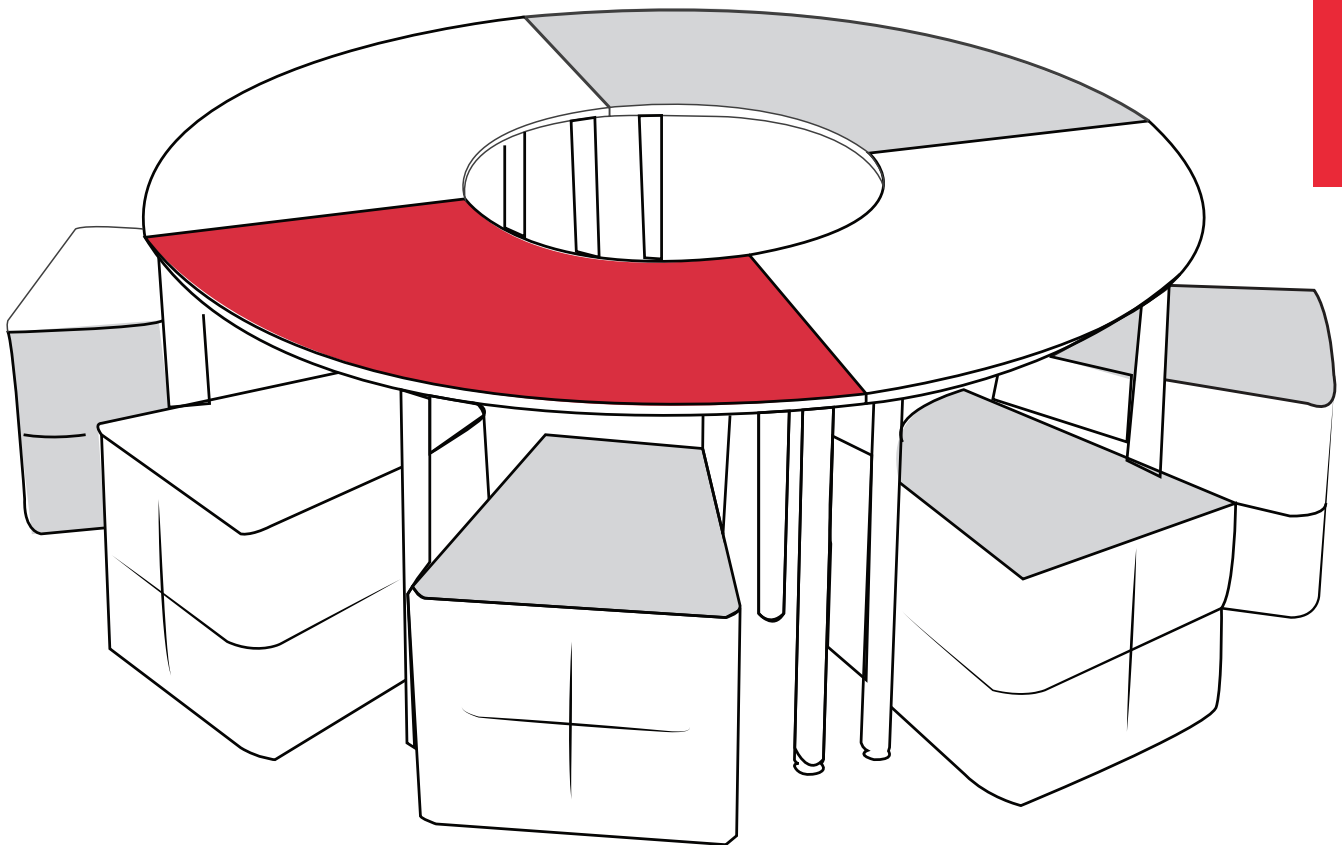

PENTAGON Single



Available Sizes	Code	Leg	Radius	Cutout	Top
900mm Radius	QUA	*	90	25	**
1000mm Radius	QUA	*	10	40	**
1500mm Radius	QUA	*	15	45	**

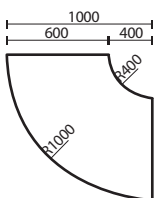
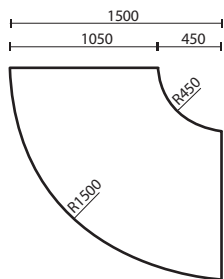
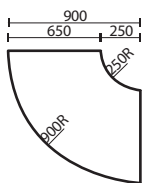

*Available leg codes are explained in detail on Page #4
 **Tops available in 18mm, 25mm or Frame Only options
 All measurements are in millimetres

QUADRANT Dimensions

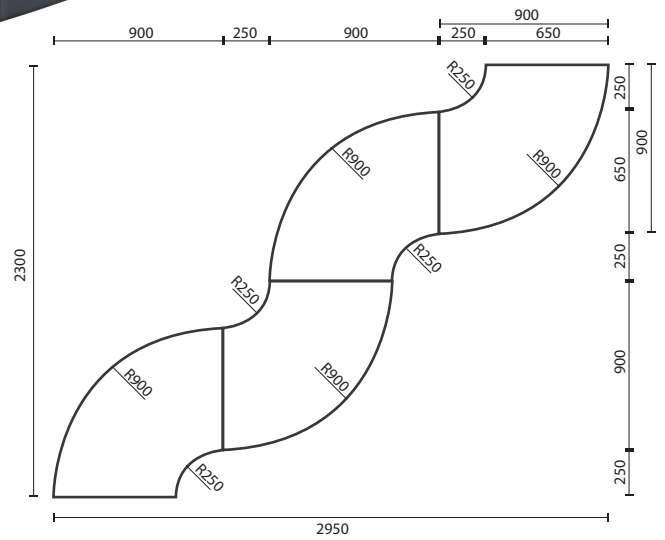



DOUBLE Quadrant

TRIPLE Quadrant

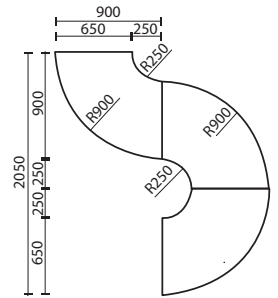
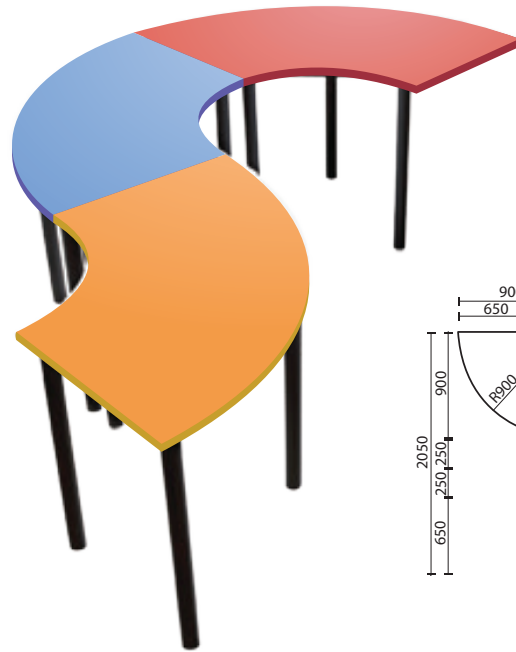
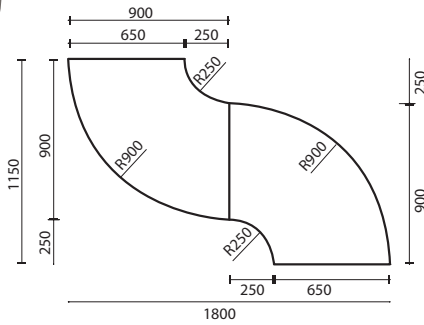

QUADRUPLE Quadrant

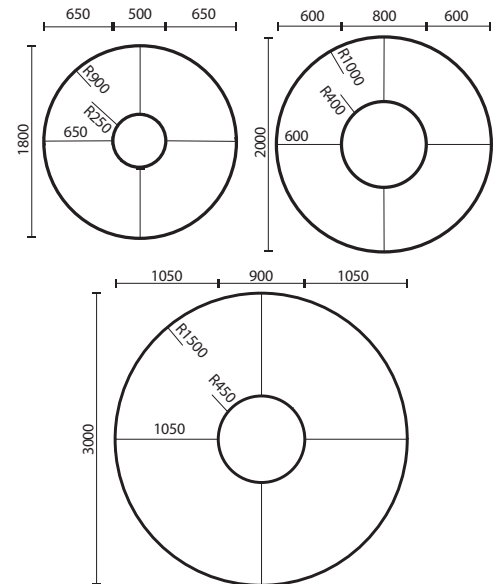

*All measurements are in millimetres

PENTAGON Table

Pentagon Tables are a unique shape within our education table range. Transforming into any number of fun, interesting and usable configurations within seconds. When arranged with other tables from our education range, Pentagon Tables are perfect for crafting a classroom experience that is truly creative.





PENTAGON Twin

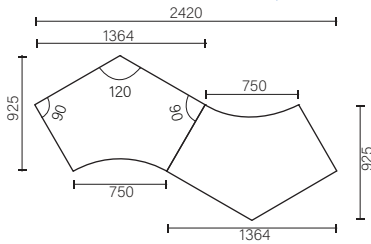
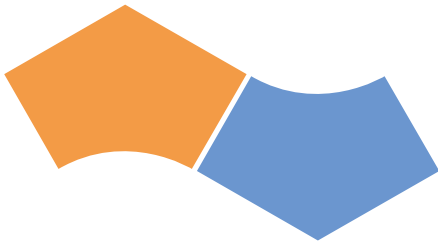

PENTAGON Triplet

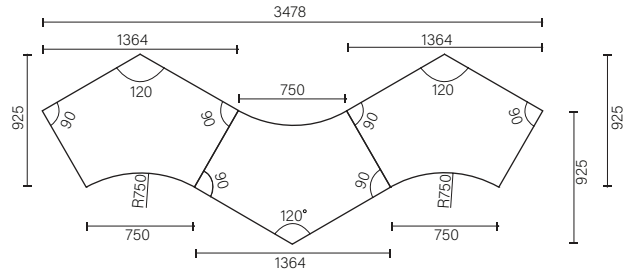
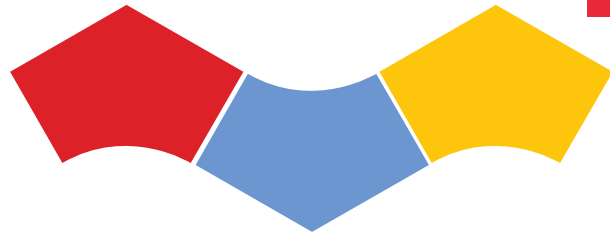

PENTAGON Campfire

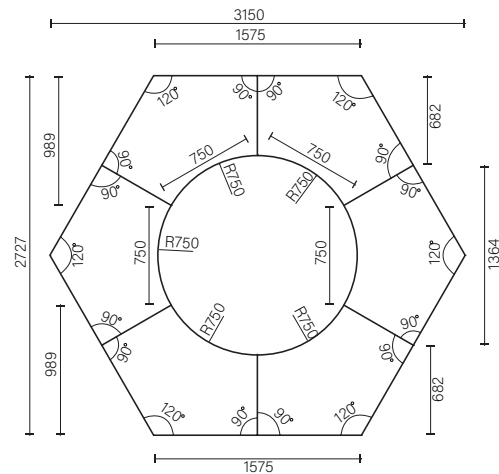

PENTAGON Single

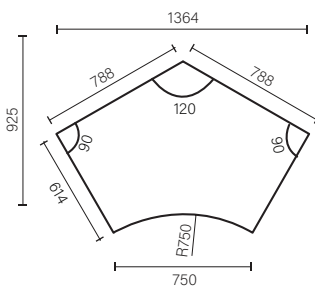

Available Sizes	Code	Leg	Width	Top
1364mm x 925mm	PEN	*	13	**

* Available leg codes are explained in detail on Page #4
 ** Tops available in 18mm, 25mm or Frame Only options
 All measurements are in millimetres

MODULAR Table

The Modular Table is a customisable range that can be used to make highly versatile configurations that do not require many specific tables or shapes. By using rectangles, squares and trapeziums, it becomes easy to create many simple, practical configurations for the classroom.



Comes With Adjustable Feet to Ensure Perfect Height

Simple Shapes Endless Configurations!

TRAPEZIUM Table

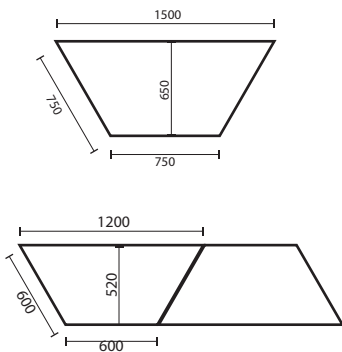

SQUARE Table

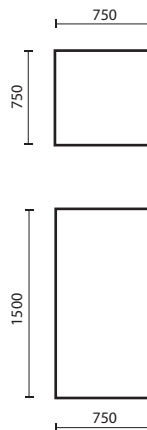

CIRCULAR Table

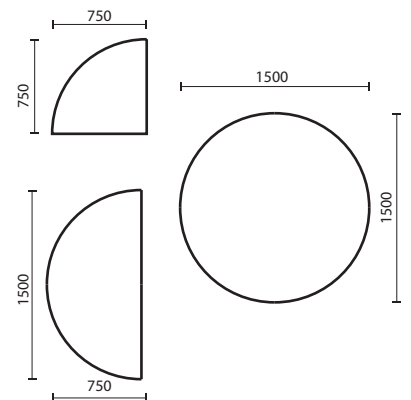



MODULAR Configurations

D - End

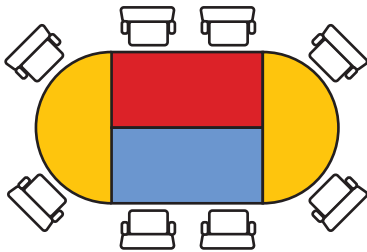

2-Piece CIRCLE

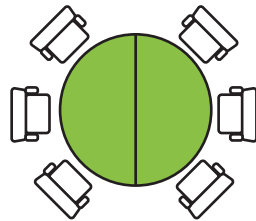

Trapezium TRI



Class RECT

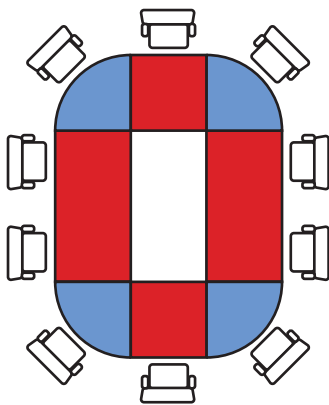

C - Corner

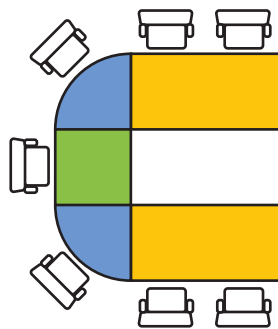

Giant HEX

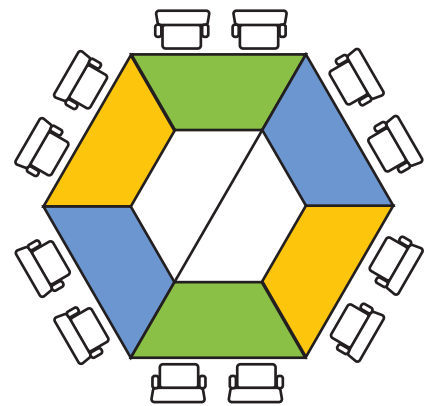

A - Frame

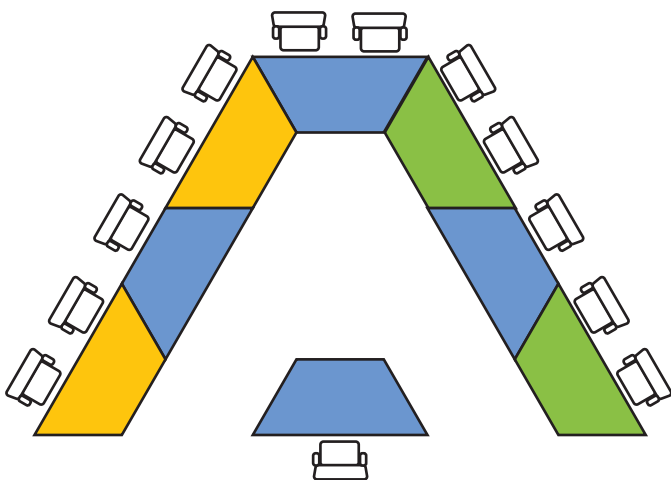

Trapezium DIAMOND

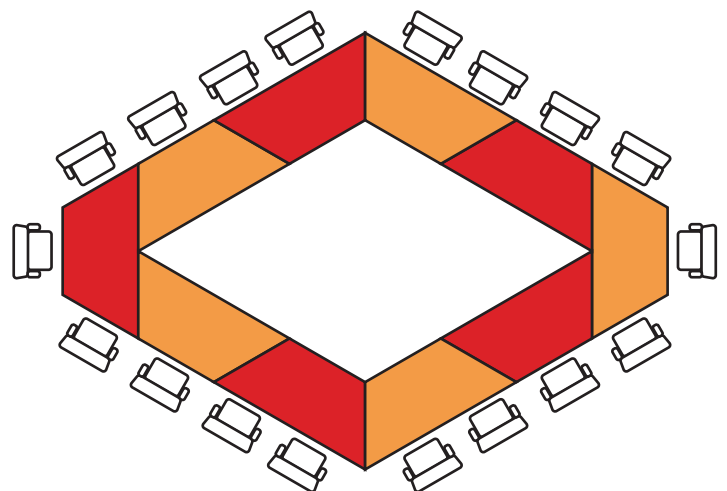

FLAG Table

The Flag Table is an excellent choice for both individual and group use. Stand alone, the Flag creates a unique working environment that inspires creativity and when used in conjunction with other Flag tables, can craft an amazing tessellating array of shapes and colours that lends well to group environments.



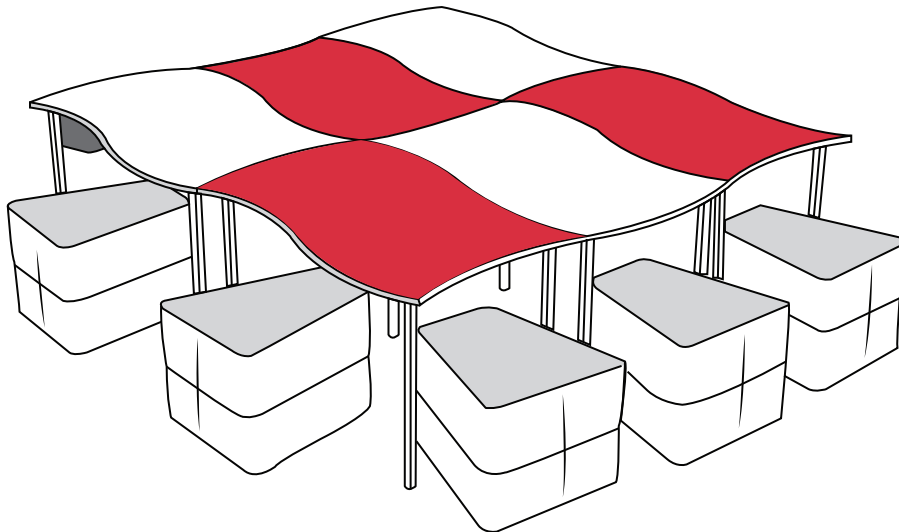

FLAG Quad

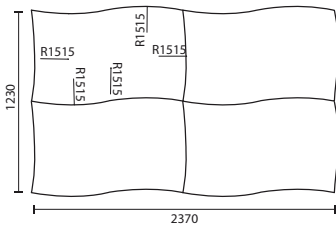
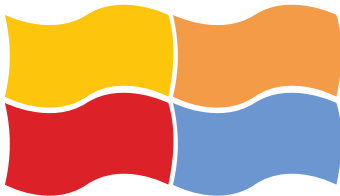

FLAG Banner

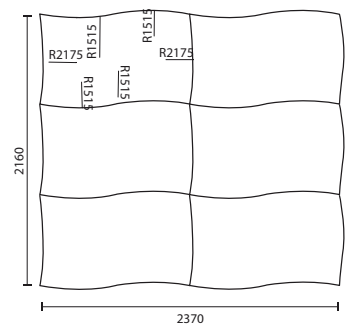

FLAG National

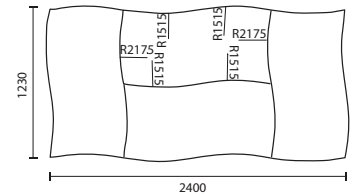

FLAG Single

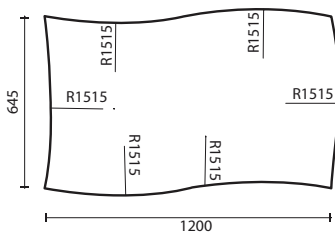

Available Sizes	Code	Leg	Width	Top
1200mm x 645mm	FLA	*	12	**

*Available leg codes are explained in detail on Page #4
 **Tops available in 18mm, 25mm or Frame Only options
 All measurements are in millimetres



TRIPOD Table

Tripod Tables create a friendly and inviting environment in which to work. With soft edges and seat space for a number of students at one table, the Tripod makes good use of valuable classroom space! The Single Tripod is designed for multiple students to use the table simultaneously. Making it perfect for use in group activity environments as well as dynamic learning settings.





ZAMPA Table

The Zampa table creates a soft edged and open environment in which to work. The shape lends well to collaborative learning with rounded corners for added safety and sense of fluidity in the learning space.



*All measurements are in millimetres



ROUND Table

The Round Table is an essential part of any classroom configuration, with a simple, versatile shape it can be effortlessly utilised with any of our other tables to provide rounded ends or neat centre links between two tables. Like other educational tables, the Round Table can be configured with height adjustable legs, making it compatible with our entire table range!

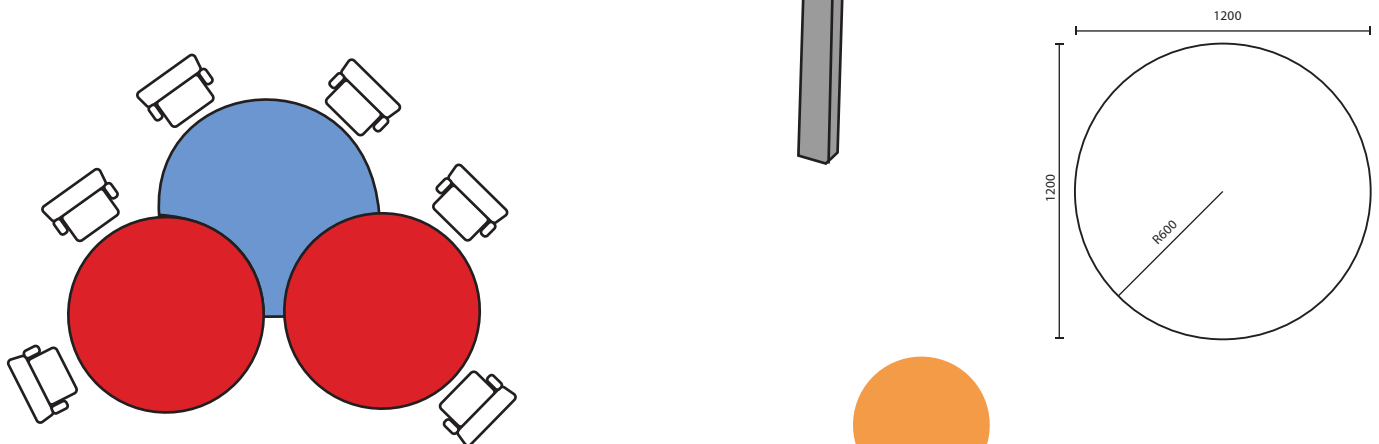
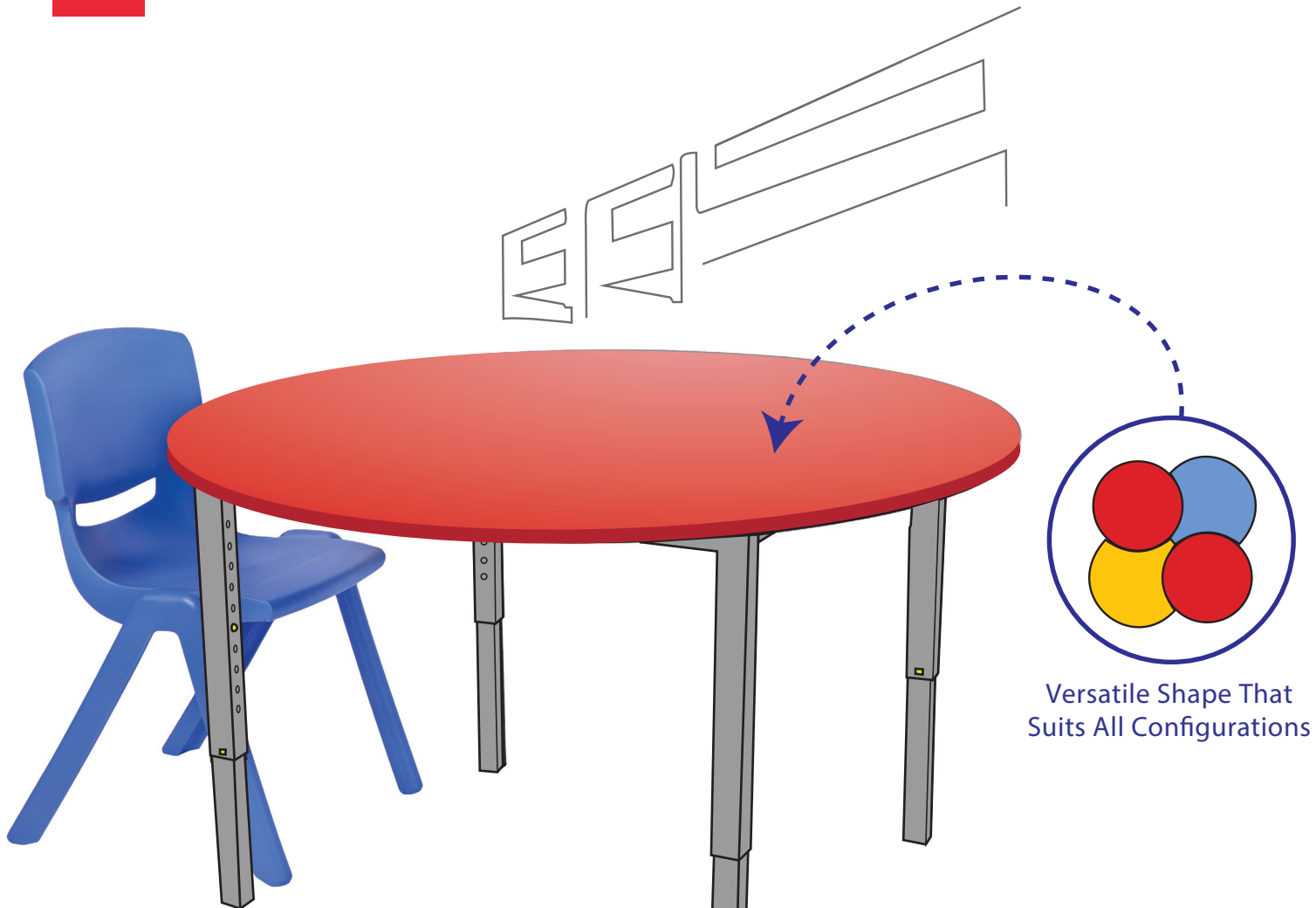

Six Student Car Configuration
Created with two 1200mm Round Tables and a single 1200mm Spade Table



SPADE Table

The Spade Table is a clean way to make seamless corners in groups of tables. The wide end comfortably and safely seats two students while the two concave curves make it a flexible building block with the rest of our range.



Pin Adjustable
Leg Height

*All measurements are in millimetres

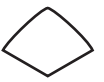

STINGRAY Table

Stingray tables make a colourful trio when joined together. Perfect for groups of two students when used alone or six students when joined together, the Stingray is a simple and clean shape with a lot of versatility!

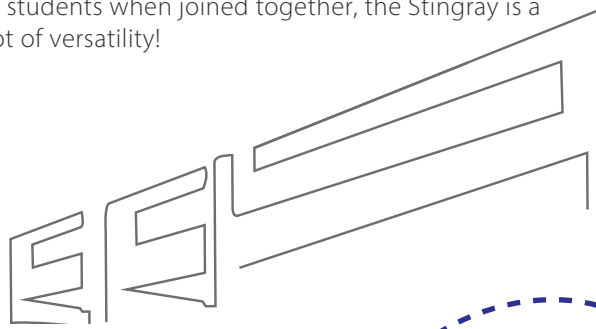

Smooth Edges
Ensure Student Safety

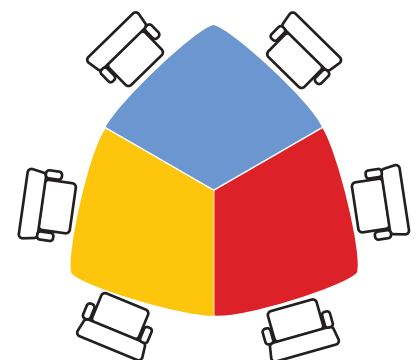
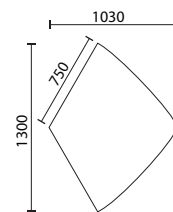

Six Student
Large Stingray Configuration
Created With Three 1300mm 1030mm
Stingray Tables



TRUSS Table

The Truss Table is one of our most flexible tables! Its uniform length means that multiple Truss tables can easily combine together to make any configuration imaginable! Take advantage of the multiple colour options available to create a truly memorable classroom experience.

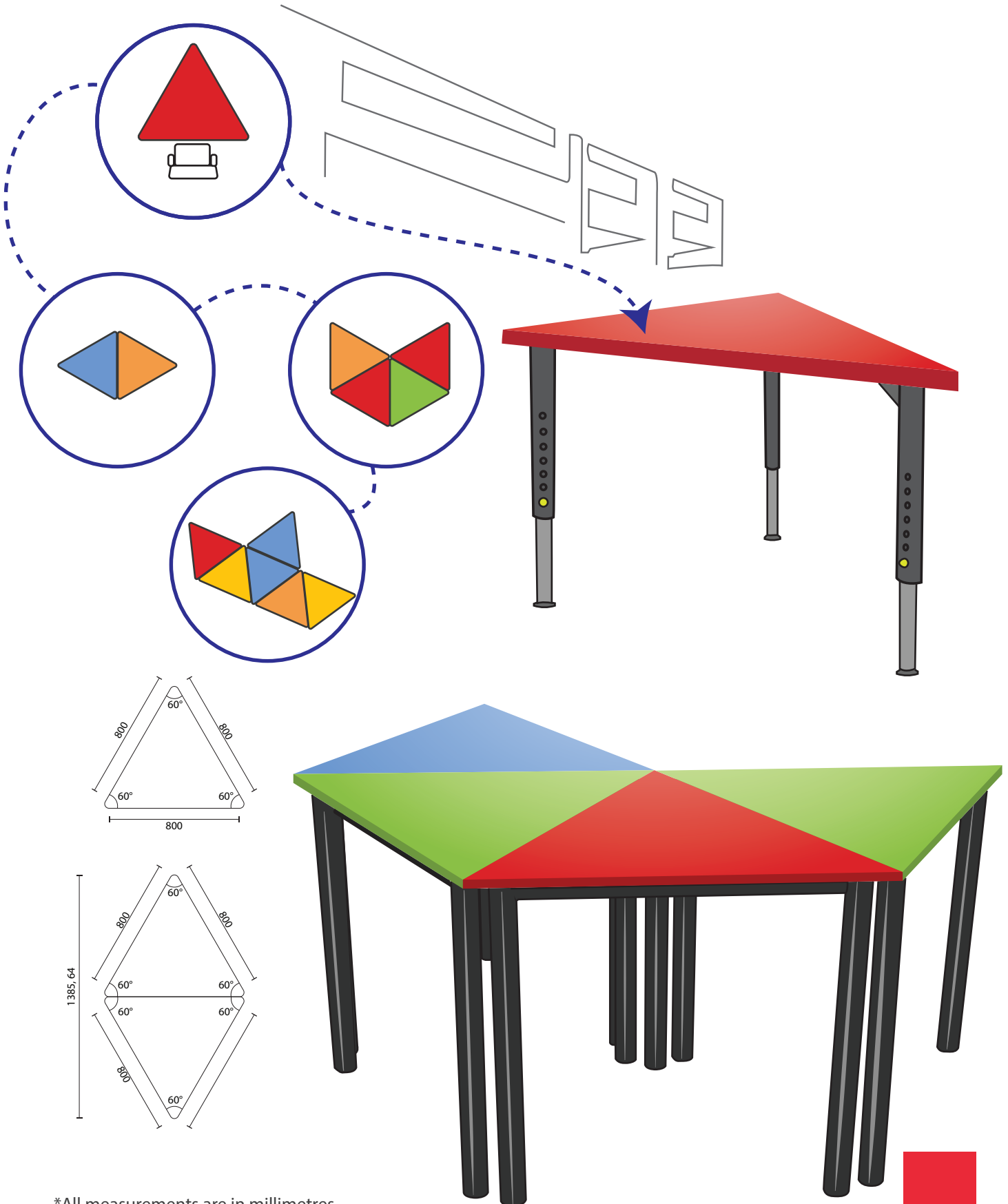

*All measurements are in millimetres



APPLE Table

Apple Tables can be used together as a bright, four-table spiral of colour, or may be used with other tables in the educational range to add a decorative flair to other configurations. Its semi-circular concave side is compatible with our Axe, Bone, Quadrant or Round tables to add a nice, open edge for student groups of two!

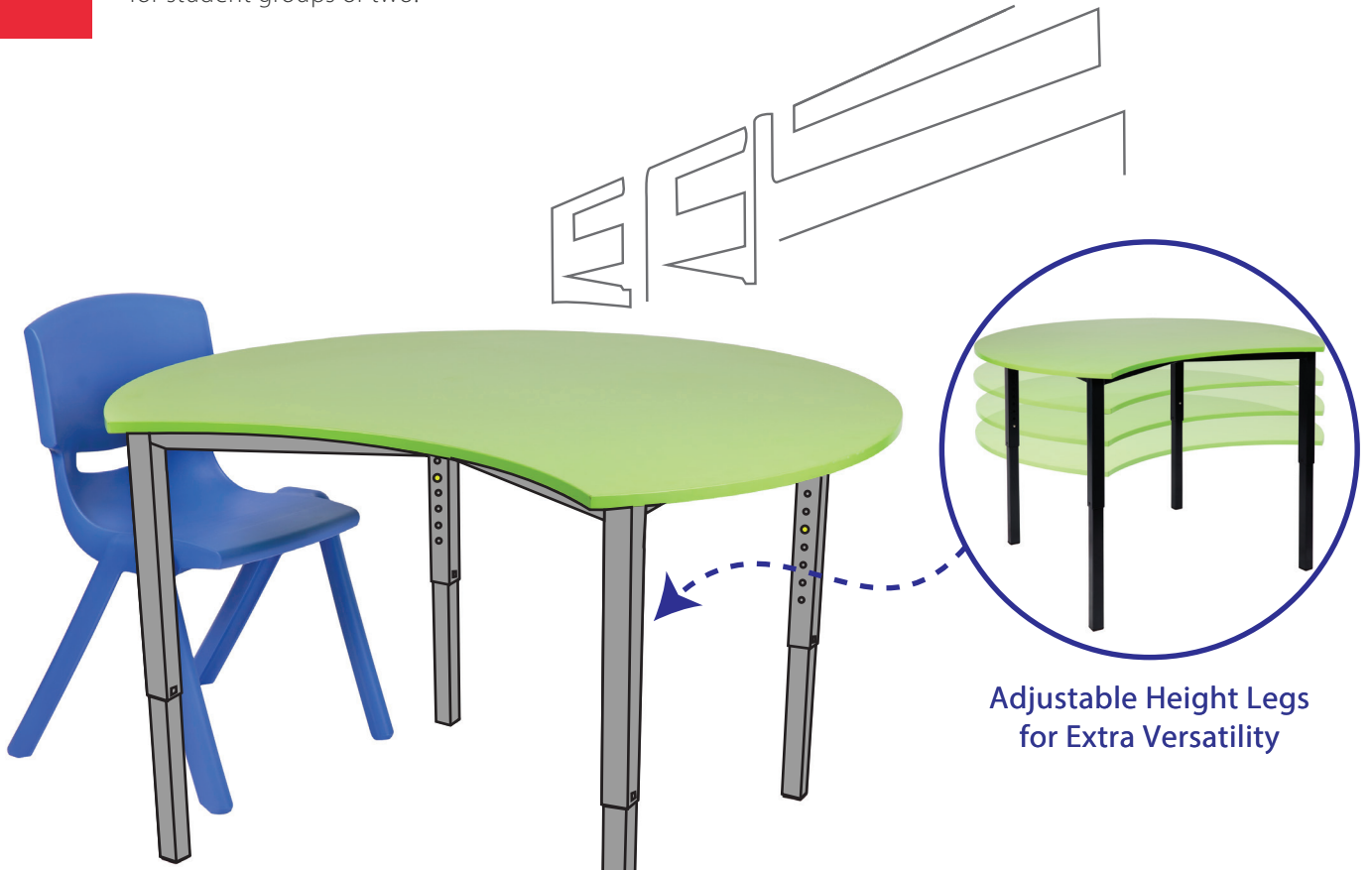

Adjustable Height Legs for Extra Versatility



Usable With Pedestal Castors for Easy Movement

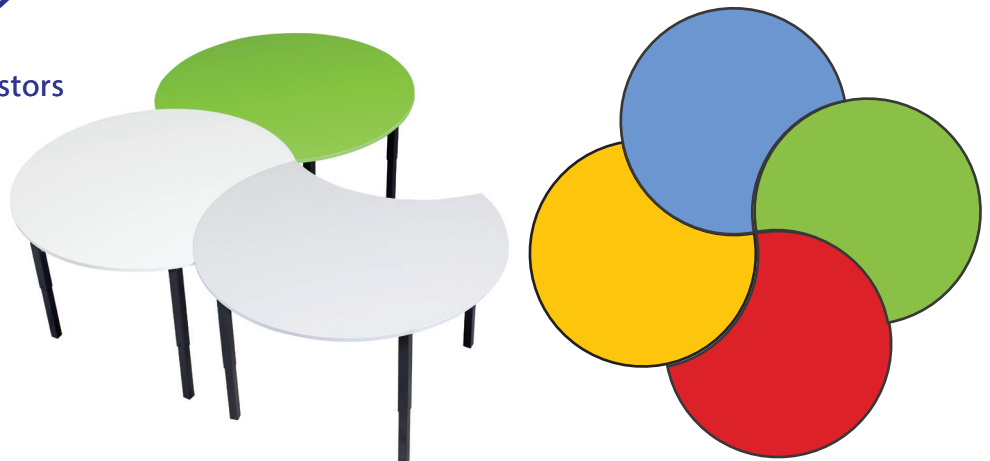
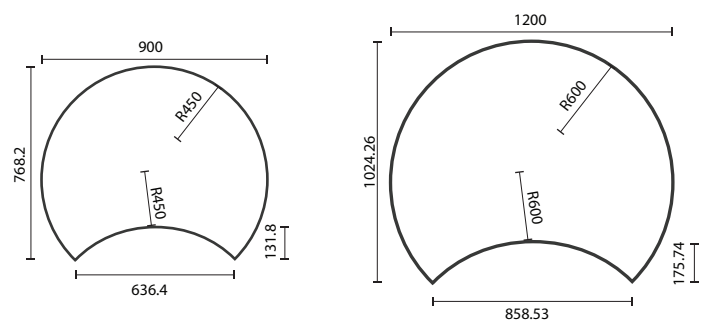



ECLIPSE Table

The Eclipse table is a bold design amongst our educational range, not only does the large, round top provide more than average working space for the creative student. But five eclipse tables can be used together to make a unique spiral of colour, perfect for larger groups of ten or more!

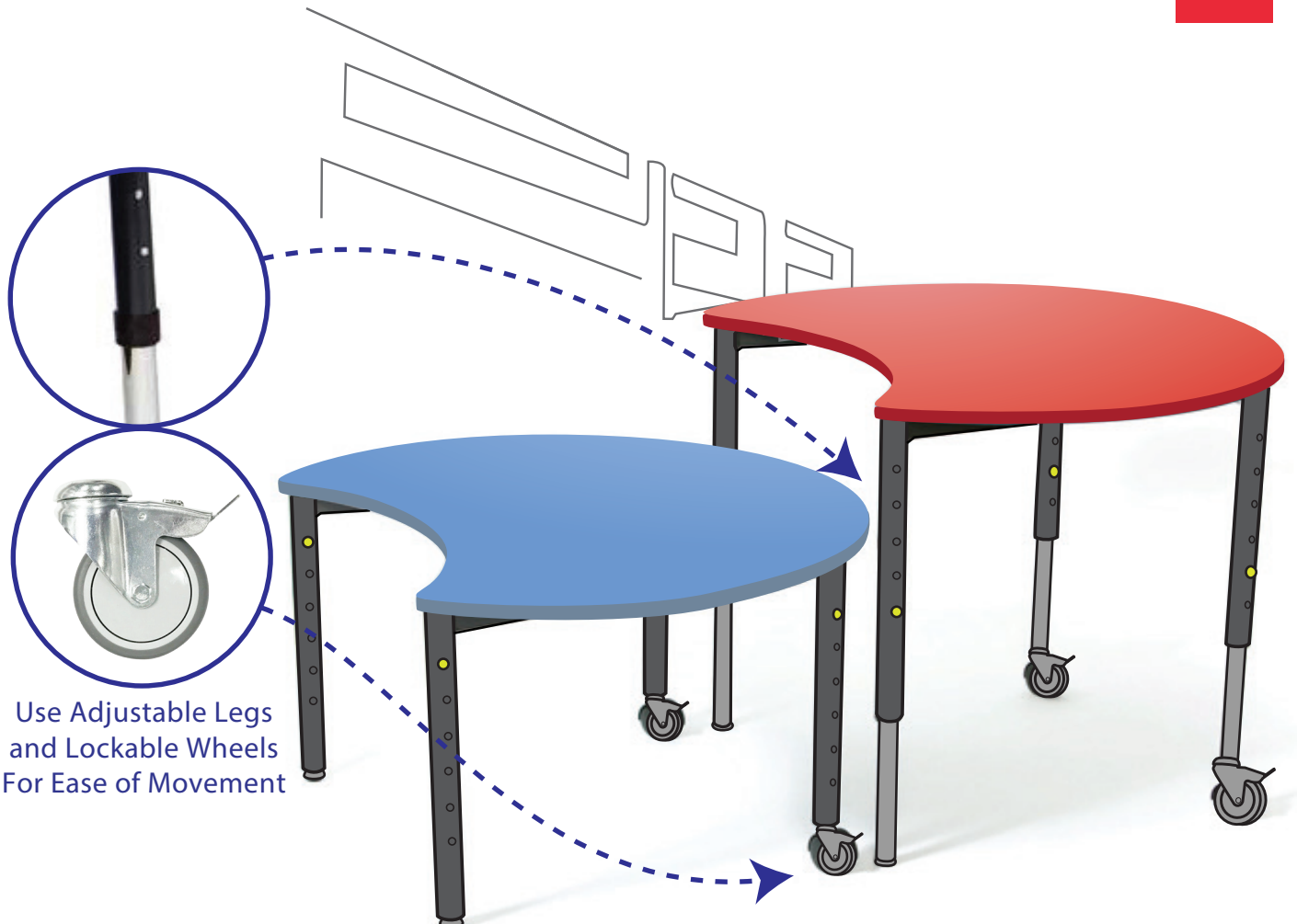

Use Adjustable Legs and Lockable Wheels For Ease of Movement

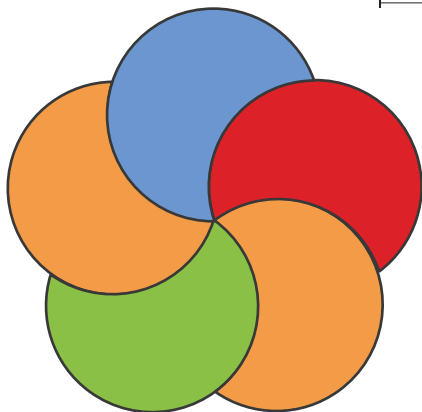
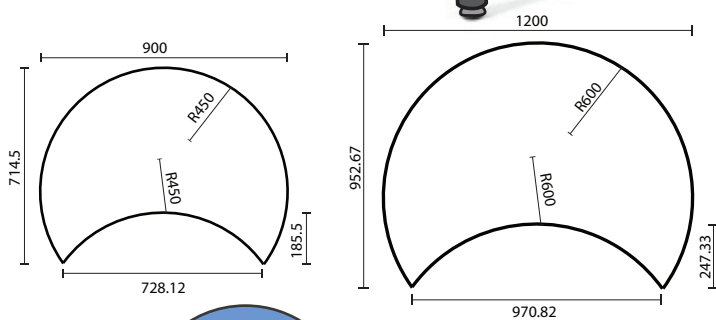

*All measurements are in millimetres



AXE Table

BONE Table

Our Axe and Bone tables really open up the classroom for larger groups. They are perfect linking pieces that can seamlessly join smaller groups of tables into larger classroom configurations for bigger group projects! The curved convex ends of the Axe table make it suitable to connect with Spade, Apple and Star tables while the singular concave end of the Bone makes it easy to use with other Bones or Spheres for a truly skeletal design!

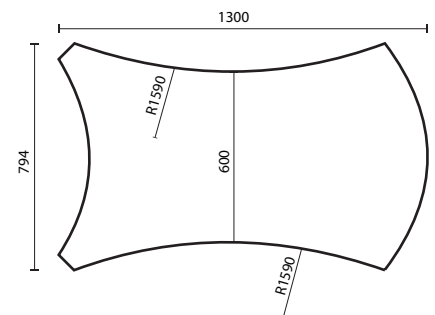
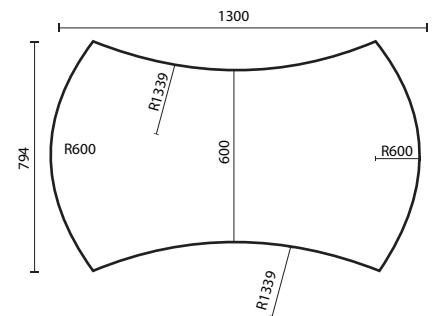

Fourteen Student Classroom Cluster
Created with Axe and Bone tables in conjunction with Star, Eclipse, Spade and Round



STAR Table

The Star Table is the ultimate centerpiece for our educational range. When used with our other tables, it can be used to create a clean, symmetrical shape that keeps a dynamic learning classroom in balance!

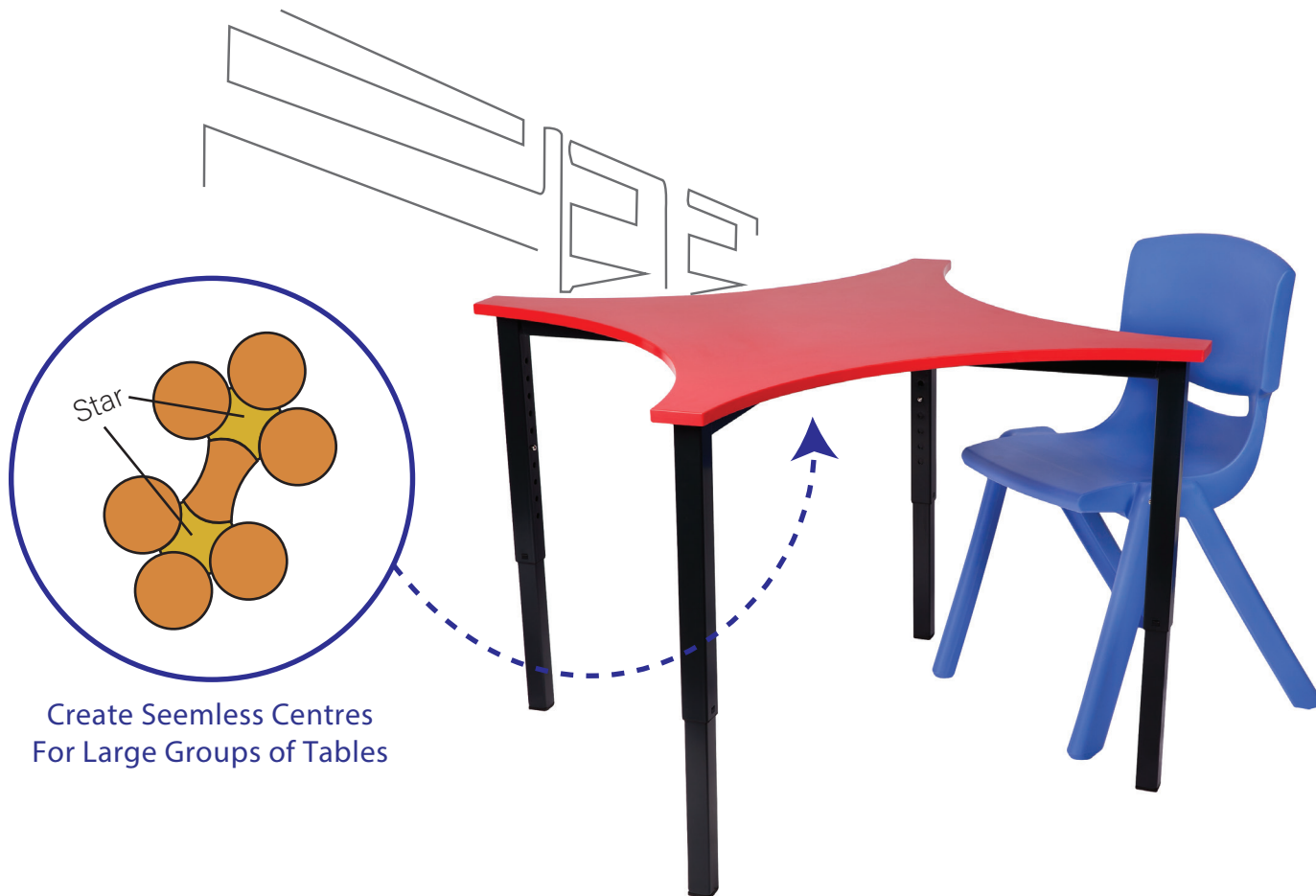

Create Seamless Centres For Large Groups of Tables

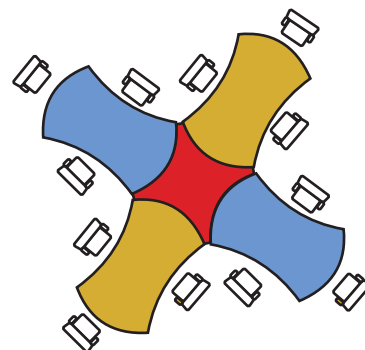
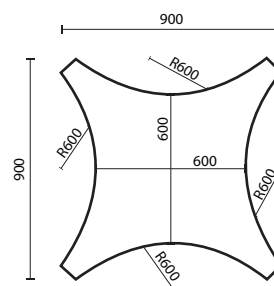

*All measurements are in millimetres



CRESCCENT Table

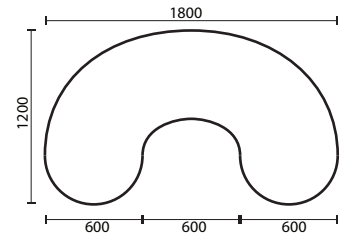

SEGMENT Table

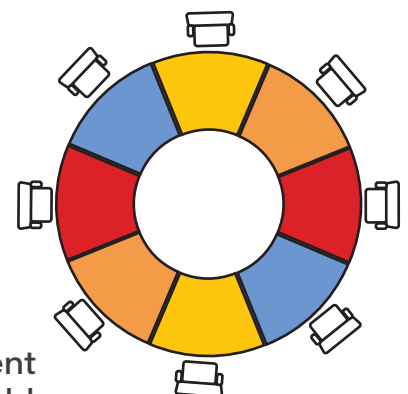
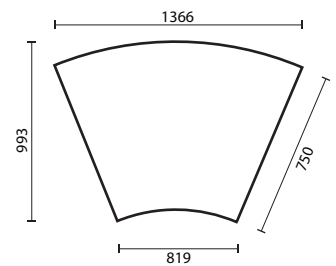

Eight Student
Carousel Table
Created with six Segment Tables



TEKNIK Table

The Teknik table is one of the largest tables in our collaborative educational range. By itself, the massive 1800mm by 900mm surface area can comfortably fit six students while the flat end may be joined with another Teknik table, suitable for large groups of students or teacher meetings.

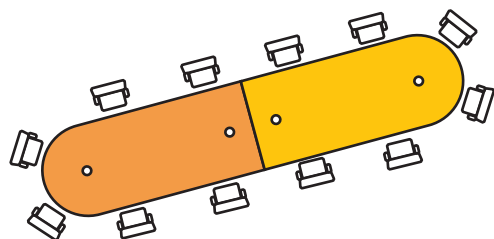
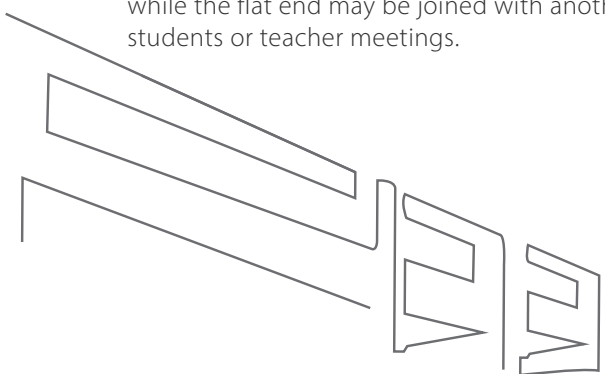

Twelve Student Boardroom Table
Created with two 1800x750mm Teknik Tables

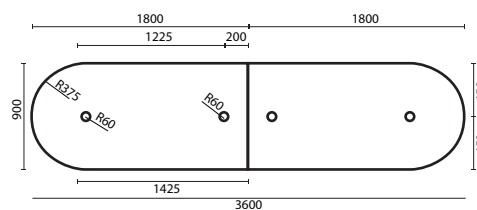
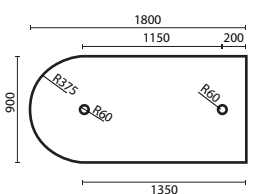
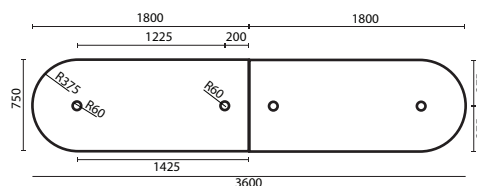
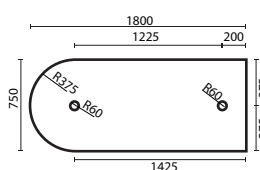

*All measurements are in millimetres

STUDENT Table



Wide Range of Colours to Suit All Classrooms



Three Years Warranty Quality Guaranteed



Drawers are optional
 Surcharges apply

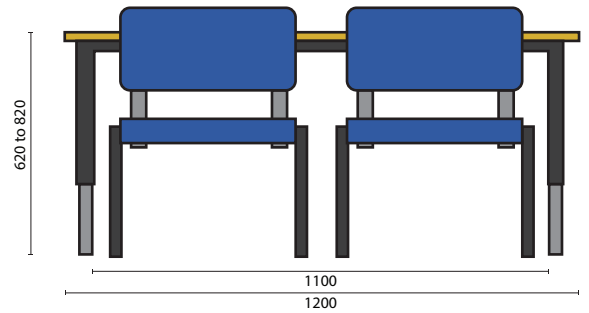

Our student tables come just as customisable as the rest of our range! All student tables are usable with two large plastic drawers that can be effortlessly removed as usable trays. In addition they may be additionally modified for adjustable leg heights, wheels and castors. Our tables also come with a full three years warranty!

TRANSIT Table

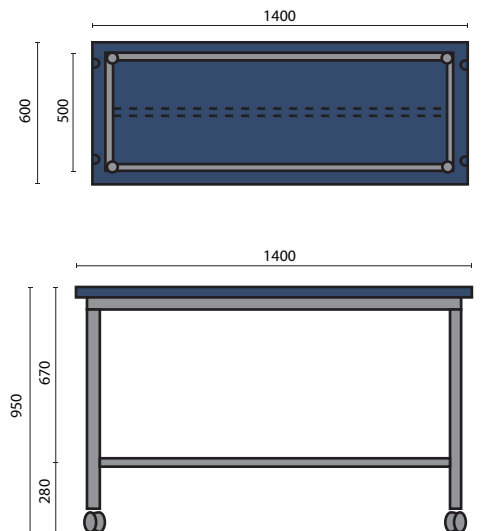

*All measurements are in millimetres

ADDITIONAL Range

We pride ourselves on crafting the perfect table that is right for you! In addition to the previous tables showcased, we can work with you to create the perfect table that is right for your teaching style and environment.

CLOUD Table

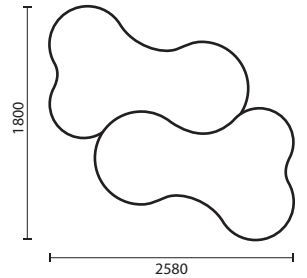
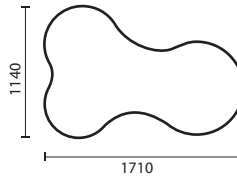
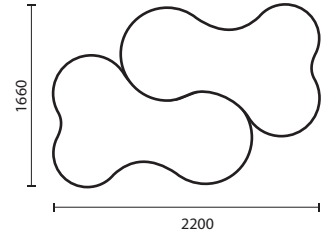
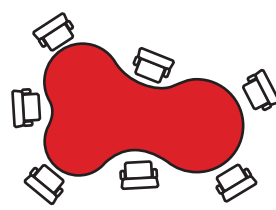
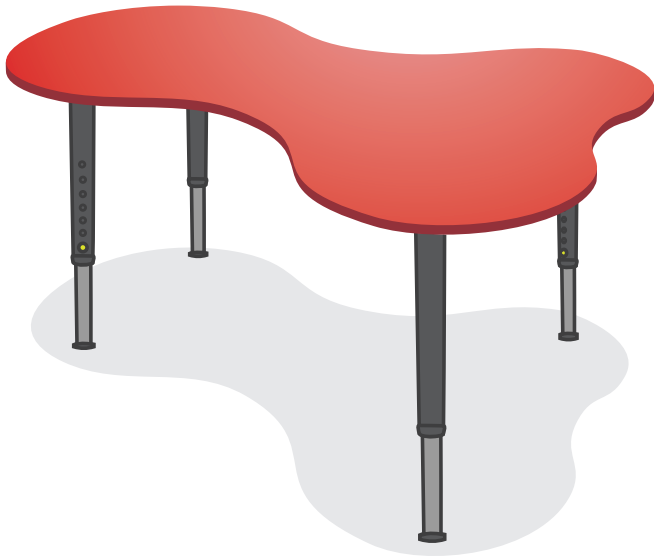

CRYSTAL Table

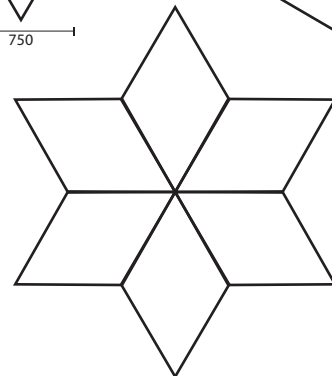
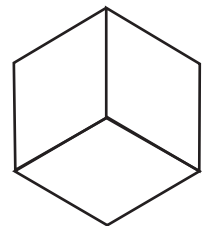
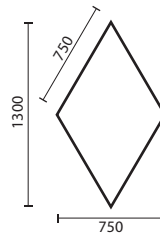
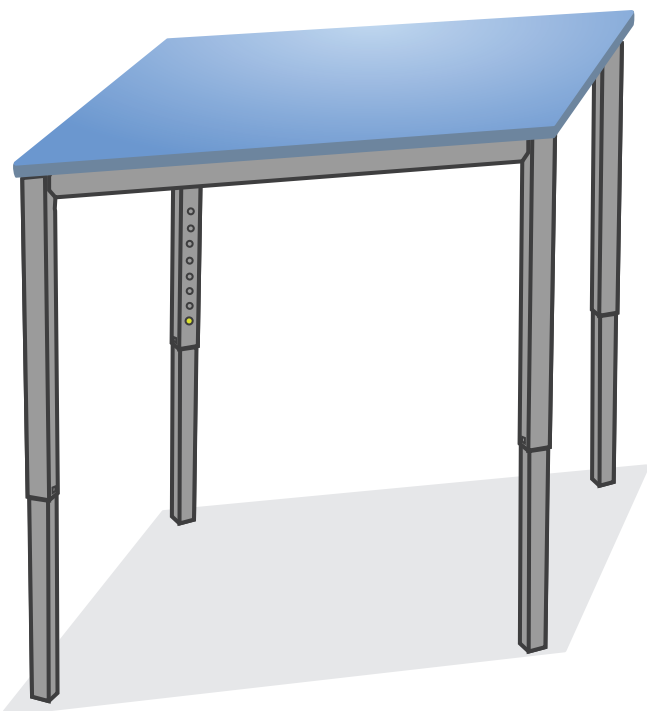

CLOVER Table

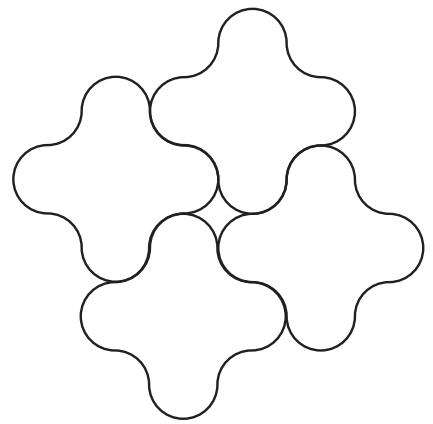
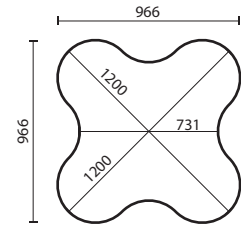

ZEN Table

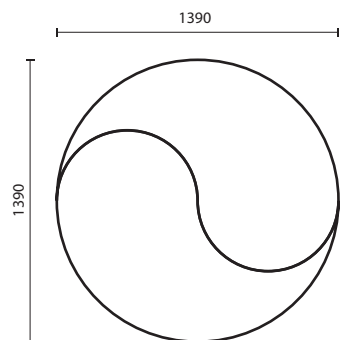
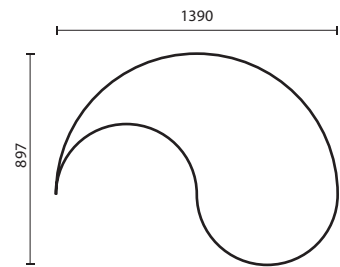

OTTOMAN Range

For an alternate seating solution, our Ottoman range creates a fun and unique configuration that provides just as much flexibility as our education table range. Available in all different shapes and sizes, they are the ideal way to tie together a collaborative learning environment. Our Ottoman range is constructed of solid Australian Made foam and upholstered in a range of house fabrics, vinyls or a fabric of your choice.



Wedge Ottoman
OTT SLI

100% Australian Made



Round Ottoman
OTT ROU 50

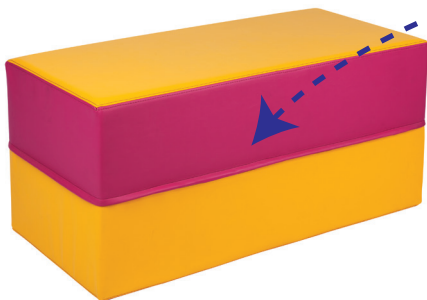
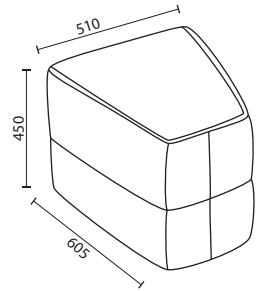
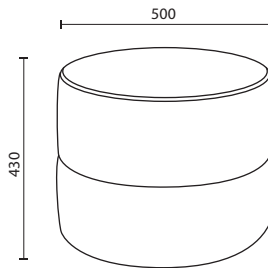

Rectangular Ottoman
OTT 90 45 45

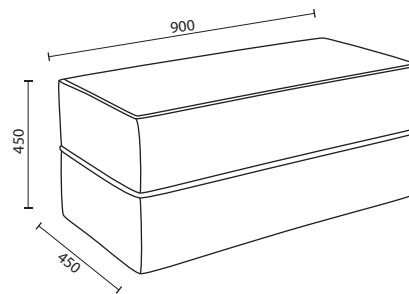

Strong Construction
That Survives The
Toughest Punishment



Kidney Ottoman
OTT KID 18 90

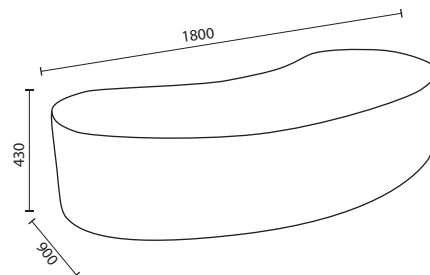

SWIFT Range

For a more traditional look in the classroom our Swift range of chairs are perfect. The Swift is available in many different colours and sizes and is constructed using high quality, long lasting polypropylene for durability and strength.



Swift 44
Swift 44

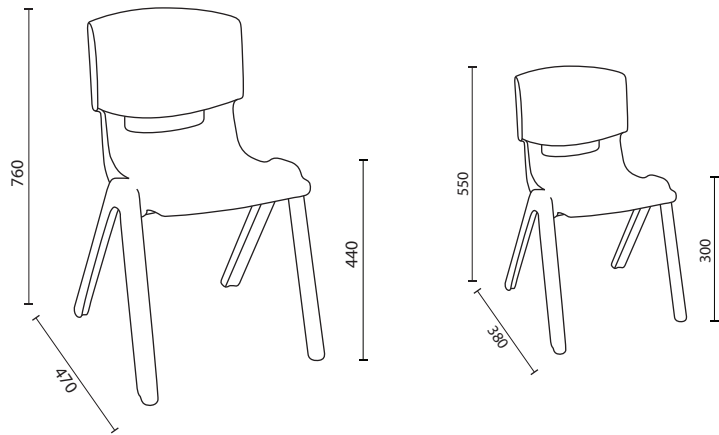

Wide Variety of Colours.
Charcoal and Blue Stocked,
all other colours available on order*



Neatly Stackable



Available in various student year groups
Size 46 and 30 stocked. All other sizes available on order*

*All measurements are in millimetres
Stocked in Black and Charcoal - Minimum Order Applies for Other Colours

SHELL / ANNE Seating

As one of our most versatile chairs, the Shell and Anne range can be outfitted with several options. Sled base for extra ease of use, a lecture table, fabric inserts for comfort or even outfit it with a gas-lift base for added versatility in the laboratory.



Shell 4 Leg
S01

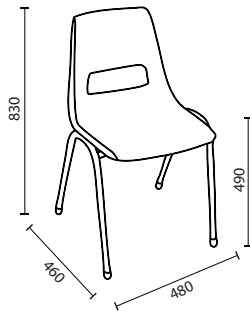

Shell Sled
SS01



Shell 4 Leg With Insert
S01 + 01



Shell Lecture
S01 + 03B



Shell Student
SG01



Anne Black Frame
A101

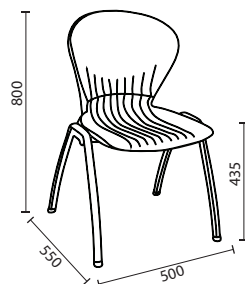

Anne Task Frame
A103 D



Anne Black With Arms
A101 + 02C



Anne Lecture
A101 + 03B



Anne Black With Insert
A101 + 01

EDUTECH Seating

The Edutech's lightweight, ergonomic design is a great option for the modern classroom. With a convenient hand grip and a seamlessly stackable shape, the Edutech is easy to move and store while the scratch-resistant seat surface can stand up to the toughest demands.



Modern, Ergonomic Design



Neatly Stackable

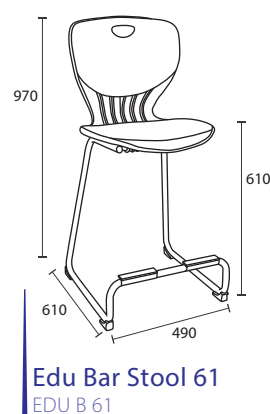
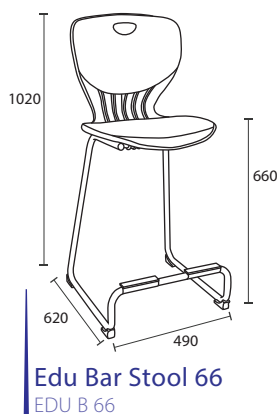
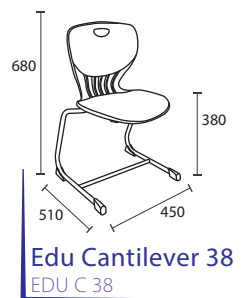
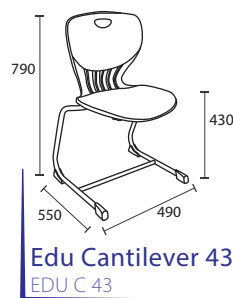
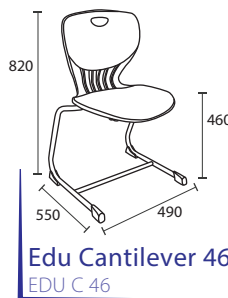
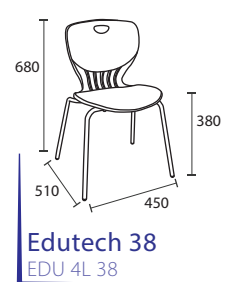
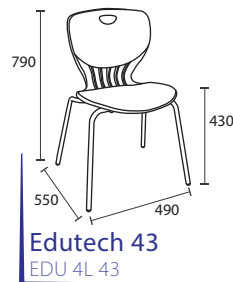
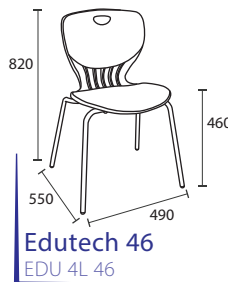

*All measurements are in millimetres
Stocked in Black and Charcoal - Minimum Order Applies for Other Colours

MULTI-PURPOSE Seating

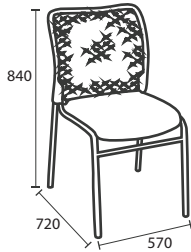

Martin 4 Leg Base
MAR 20 4L B

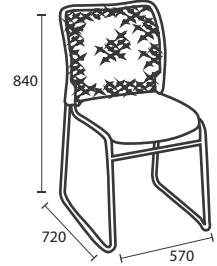

Martin Sled Base
MAR 20 SL B

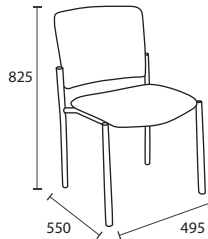

Lazer 40 Side Chair
LAZ 40 4L B

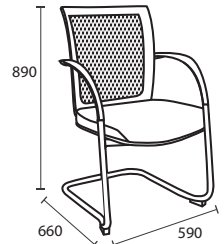

Tesla Cantilever
TES CA MEA

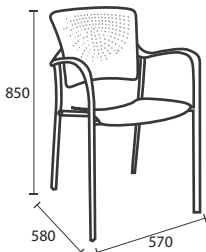

Sienna Multi Purpose
SIE 66

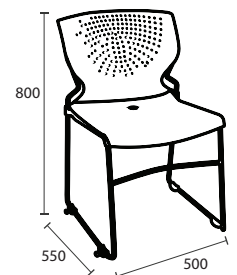

Sabi Chair
SABI 800



*All measurements are in millimetres
For the whole task range refer to general catalogue

LECTURE Seating



Martin Lecture
MAR 20 4L B + 03B

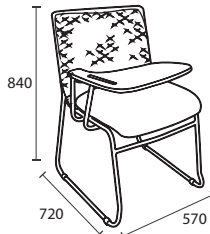

Bistro Lecture
BIS 001 + 03B

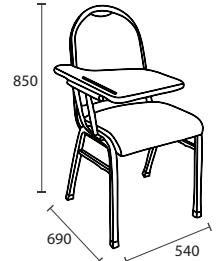

Nova Lecture
NOV 001 + 03B

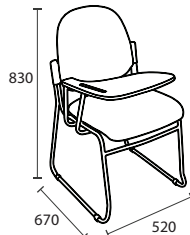

Joshua Lecture
JOS 601 + 03B

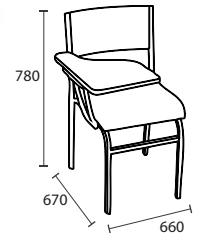

Shell Lecture
S01 + 03B

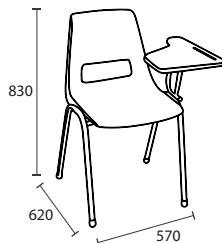

Anne Lecture
A101 + 03B

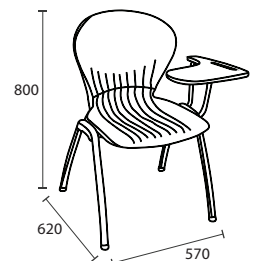

*All measurements are in millimetres
For the whole lecture range please refer to our general catalogue

LAB Seating

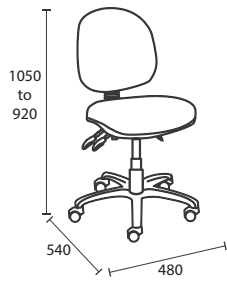

Ergo Clerical
ERG 300

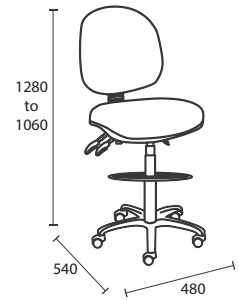

Ergo Drafting
ERG 300 D

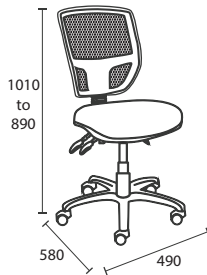

Lily Task
LIL 30

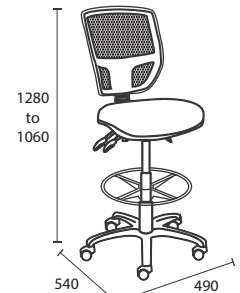

Lily Drafting
LIL 30 D

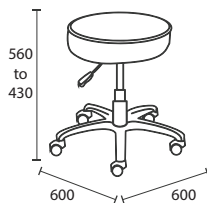

Solo Adjustable Stool
SOL 5

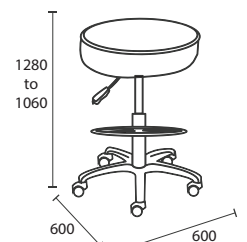

Lab Stool
LAB D S

*All measurements are in millimetres
For the whole task range refer to general catalogue

EXECUTIVE Seating

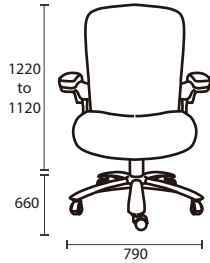

BIFMA
INTERNATIONAL

5
YEARS
WARRANTY



Boeing PU - Bariatric Executive
BOE EX PU

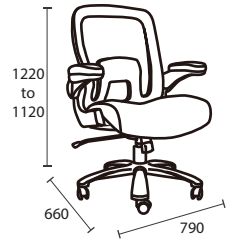

BIFMA
INTERNATIONAL

5
YEARS
WARRANTY

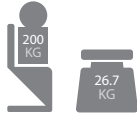

Boeing Mesh - Bariatric Executive
BOE EX ME

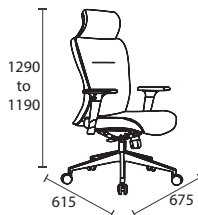

BIFMA
INTERNATIONAL

furntech
Australian
Furnishing
Research &
Development
Institute

3
YEARS
WARRANTY

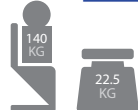

Bentley Executive High Back
BE 40 EX CH HB

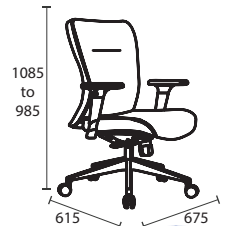

BIFMA
INTERNATIONAL

furntech
Australian
Furnishing
Research &
Development
Institute

3
YEARS
WARRANTY



Bentley Executive Low Back
BE 40 EX CH LB

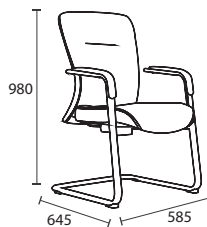

furntech
Australian
Furnishing
Research &
Development
Institute

3
YEARS
WARRANTY

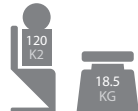

Bentley Cantilever
BE 40 CA CH

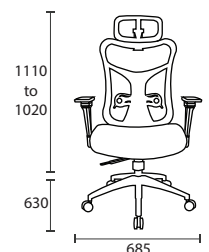

3
YEARS
WARRANTY



Avatar Mesh Executive
AVA EX CH +HR

*All measurements are in millimetres
For the whole executive range please refer to our general catalogue

This Education Catalogue is to be studied as part of our extensive range of products

Chairs and Bar Stools



Health Care Range



Joshua Comfort Range



Executive and Task



Table Range



Dining Range

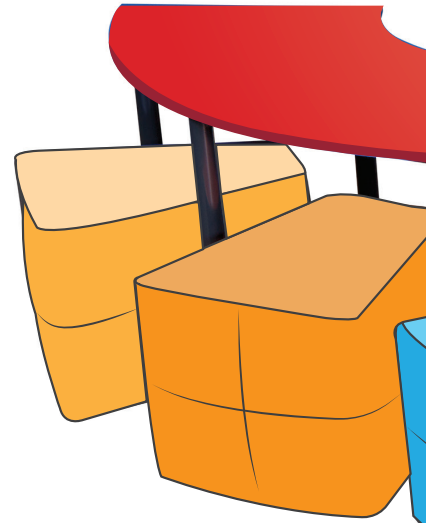

Distributed By

